



Vertiv™ Liebert®

EXM2

100 to 250 kW

Highly Reliable and Efficient
UPS designed to provide
industry-leading performance



About Vertiv

Vertiv brings together hardware, software, analytics and ongoing services to ensure its customers' vital applications run continuously, perform optimally and grow with their business needs. Vertiv solves the most important challenges faced by today's data centers, communication networks and commercial and industrial facilities with a portfolio of power, cooling, and IT infrastructure solutions and services that extends from the cloud to the edge of the network. Headquartered in Columbus, Ohio, USA, Vertiv employs around 20,000 people and does business in more than 130 countries. For more information, and for the latest news and content from Vertiv, visit [Vertiv.com](https://www.vertiv.com).

Vertiv.com

OUR PURPOSE

We believe there is a better way to meet the world's accelerating demand for data - one driven by passion and innovation.

OUR PRESENCE

GLOBAL PRESENCE

Manuf. and Assembly Locations **19**
Service Centers **270+**
Service Field Engineers **2,700+**
Technical Support/Response **330+**
Customer Experience Centers/Labs **17**



US AND CANADA

Manuf. and Assembly Locations **7**
Service Centers **120+**
Service Field Engineers **850+** Technical Support/Response **120+** Customer Experience Centers/Labs **4**

LATIN AMERICA

Manuf. and Assembly Locations **1**
Service Centers **20+**
Service Field Engineers **300+** Technical Support/Response **25+** Customer Experience Centers/Labs **2**

EUROPE, MIDDLE EAST AND AFRICA

Manuf. and Assembly Locations **5**
Service Centers **70+**
Service Field Engineers **600+** Technical Support/Response **95+** Customer Experience Centers/Labs **6**

ASIA PACIFIC

Manuf. and Assembly Locations **6**
Service Centers **60+**
Service Field Engineers **950+** Technical Support/Response **90+** Customer Experience Centers/Labs **5**

Liebert® EXM2, The Next Generation Mid-size UPS for Mission-critical Applications

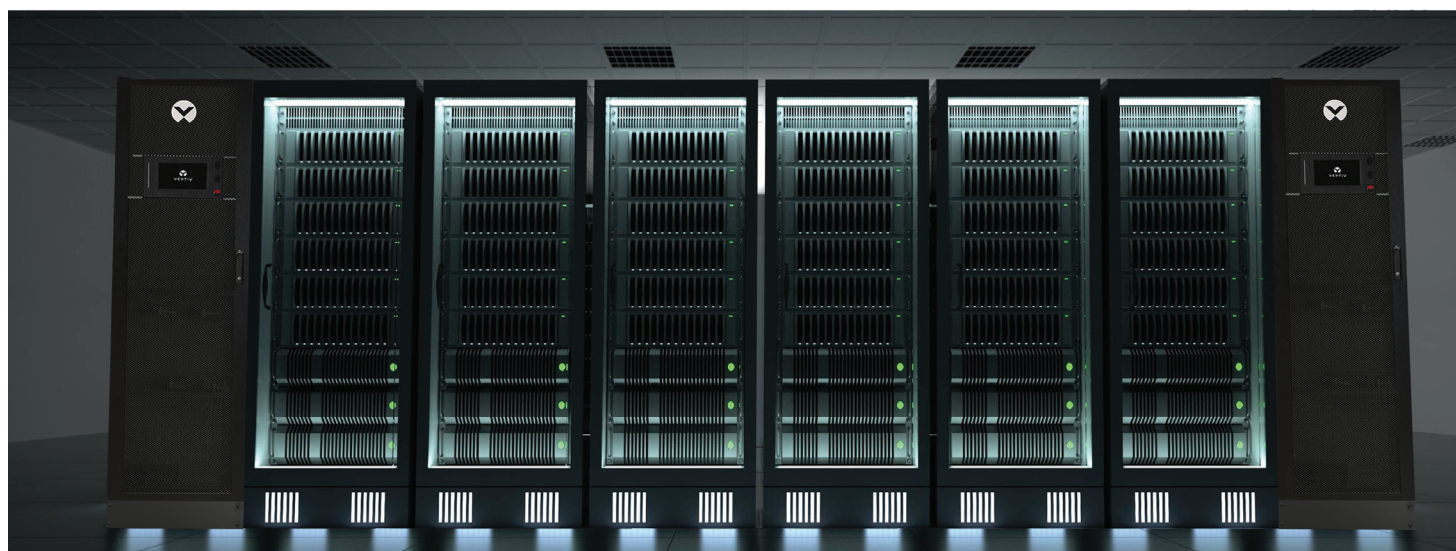





HIGHLIGHTS

- Power Capacity: 100, 120, 160, 200 and 250 kVA/kW
- Three modes of operation to boost TCO and performance
- Maximum efficiency in the Mid-size range: Up to 98.8% in Dynamic online mode and Up to 97% in Double conversion mode
- Diverse application scenarios: In-Row, Room and Against-the-wall
- Flexible battery configuration: Lithium-Ion Batteries compatibility & adapts to two wire connection
- Symmetrical Power Factor (0.5 leading to 0.5 lagging)
- Scalable in parallel up to 1.5 MW
- High ambient temperature up to 50 °C with auto-derating above 40 °C
- Reliability boosters: Robust air channels, PCBs embedded with conformal coating
- Seismic complaint (with optional kit)

Vertiv™ Liebert® EXM2 drives its evolution from the flagship Liebert® EXM/Liebert® NXC- which has been widely recognized as proven and highly stable performing UPS in its range and has been supporting over thousands of critical sites across the globe. Backed by dedicated research of Vertiv experts, Liebert EXM2 is poised to lead in the industry with technologically advancements implanting all the next-gen attributes. Machine learning based- **Three modes of energy operation** ensures **the best energy credentials and assures maximum availability.** Its

extraordinary Double conversion efficiency up to 97% ensures remarkable operational cost savings. Our proven Dynamic online mode delivers efficiency up to 98.8% whilst compensates the load THDi, PF, main sags and swells, ensuring fast transfer output performance. On top of this, Liebert EXM2 adopts to a range of infrastructure conditions including **Lithium-ion battery compatibility and supports for the leading power factor** needs of modern server loads. Seamlessly operates up to 40 °C and **can tolerate high ambient temperature up to 50 °C** with auto-derating.

Healthcare	Railway/Metro	Enterprises	Light Industries
 <ul style="list-style-type: none"> • Health Diagnostic Equipments • Datacenter • CPSS 	 <ul style="list-style-type: none"> • Communication System • Automatic Fare Collection • CPSS • Operational Control Center 	 <ul style="list-style-type: none"> • Datacenter • CPSS • Work stations 	 <ul style="list-style-type: none"> • Critical Process Equipments • Datacenter • CPSS • Work stations

Flexible And Optimized Design

Aesthetic Design Adapts Well Into Your Infrastructural Needs

- Ideal for In-the-Row server rack applications
- Suitable to be installed against the wall using optional top fan kit
- Suitable to be installed adjacent to the wall
- **Compact and lightweight footprint** saves significant white floor space



- 1 Bypass Section
- 2 Power Section
- 3 Integrated Surge Protection
- 4 Switch Assembly
- 5 Cable Termination Section (Bottom as standard)
- 6 Top cable Termination panel (Optional)

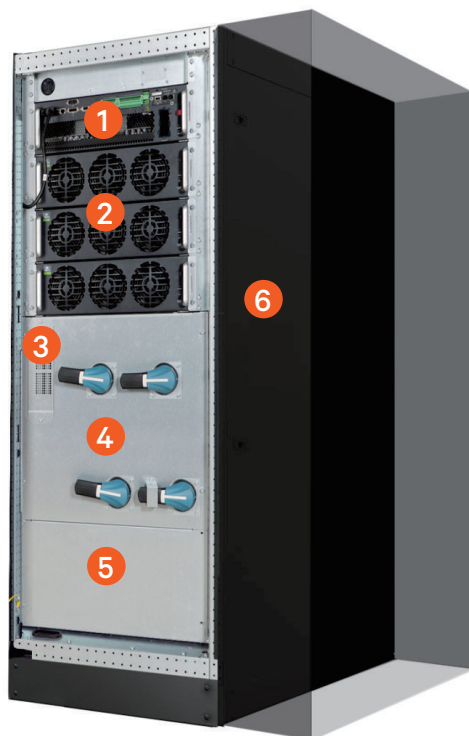

100-160 kVA

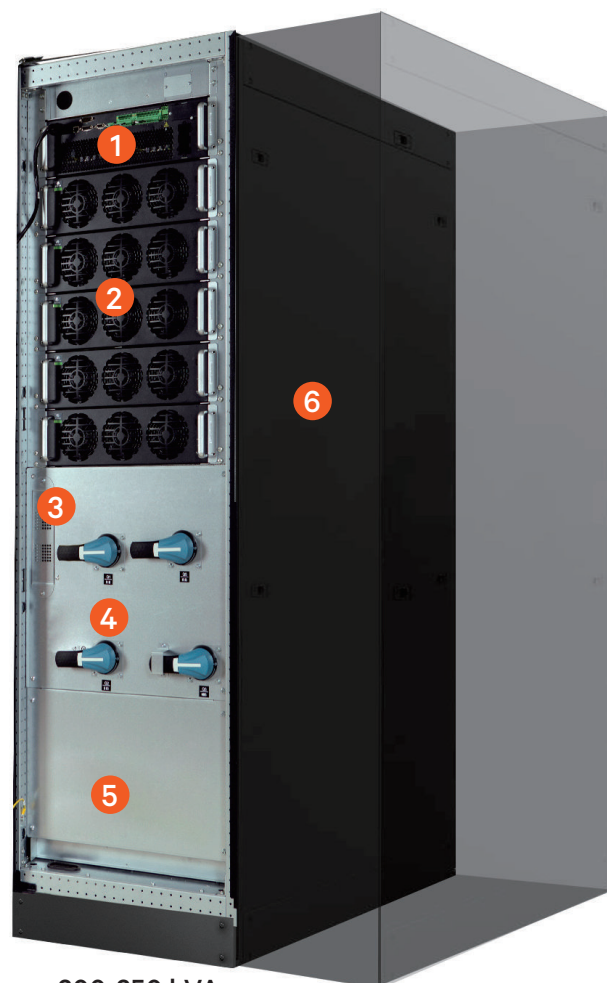

200-250 kVA

Highly Efficient and Lowest TCO

Liebert® EXM2 delivers an **outstanding Double conversion efficiency of up to 97%**, which further increases up to 98.8% with the Dynamic online mode, consequently **reducing operating costs and energy dissipation (kW)** to a minimum. This significantly minimizes the consumption of the cooling system, providing an overall TCO reduction and rapid payback time.

Furthermore, the Liebert EXM2 can optimize efficiency at partial load thereby attaining additional cost savings through the intelligent paralleling feature. The efficiency

and electricity cost savings of Liebert EXM2 can be attributed to:

- Latest generation IGBT
- Adoption of a three-level T-type converter topology
- DC controlled fan speed
- Intelligent paralleling mode
- Advanced digital technology and fast transfer

The seamless activation of Liebert EXM2's functioning modes ensures the **highest level of efficiency without compromising power quality and availability**. The Dynamic online mode ensures

Class 1 output performance under most stringent conditions:

- Network fault (voltage variation, high/ low impedance mains failures)
- Load fault (short circuit downstream of the UPS)
- Type of load connected (PDU transformer)

The unit discriminates between various interferences and responds rapidly, meanwhile also **ensures compatibility with downstream equipment** (such as Transformers, STS, mechanical loads, etc).

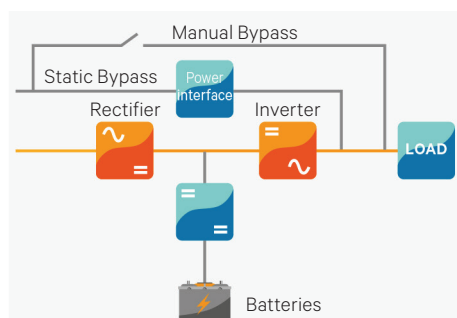

Maximum Power Control (VFI)

Provides the highest level of power conditioning and protects the load from all electrical network disturbances.

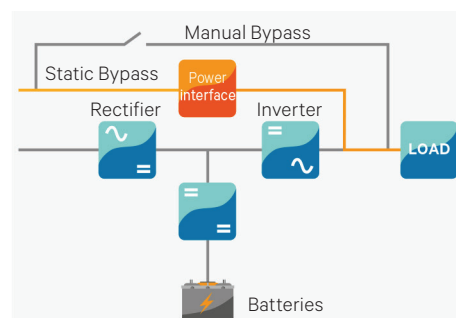

Maximum Energy Saving (VFD)

Detects when conditioning is not required and allows the energy flow to pass through the bypass line.

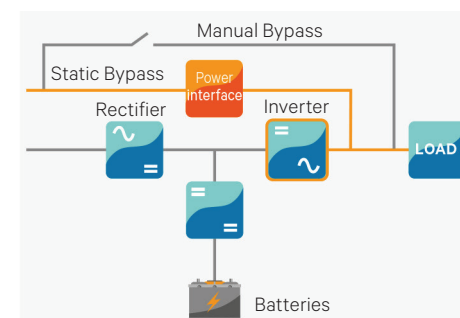

Dynamic Online, High Efficiency & Power Conditioning (VI)

Compensates the load THDi, PF, main sags and swells, ensuring fast transfer output performance.

Dynamic online mode: No more availability tradeoff with efficiency

Dynamic online mode is the latest high efficiency mode of operation offered by Vertiv, developed for those that do not want to trade off any level of availability for incremental gains in efficiency.

Dynamic online mode enables **operating efficiency up to 98.8% without sacrificing availability**. In fact, while in this mode, the inverter can instantaneously assume the load and maintain the output voltage

within the IEC 62040 Class 1 specification, thus offering the same level of availability typically achieved in a double conversion operating mode.

Dynamic online mode is therefore able to combine the superior availability of a Double conversion operating mode with the excellent energy cost savings of a high efficiency mode for a reduced total cost of ownership.

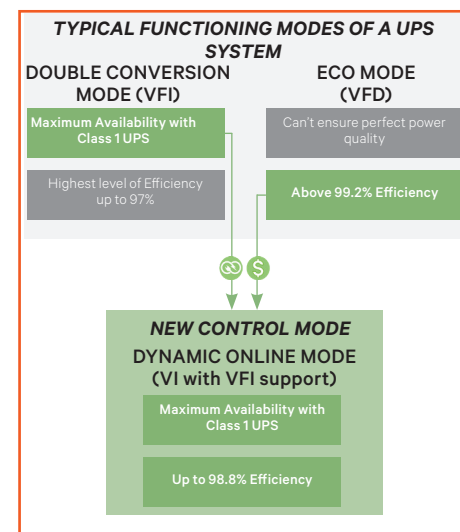

Robust & Proven Design

Innovative Internal Air Channel

Designed in such a way that internal hot air drives directly towards heat sink without distressing the PCB's and other internal sensitive circuits, **improving the service life of components and UPS reliability.**

Conformal Coating

Applied as standard feature for all PCBs in Liebert® EXM2. Its primary purpose is to **protect electronics from environmental elements and corrosion.** The coating acts as both a protective shield and insulative material for a PCB.

Higher Short Circuit Handling Capacity

During the short circuit, load will be transferred via bypass to clear higher short circuit currents. Fuse is considered optionally to

clear short circuit capacity of **up to 65 kA.**

Tolerates Higher Ambient Temperatures

Internal components and circuitry of Liebert EXM2 are designed to **seamlessly operate up to 40 °C** without any capacity impact and further **can sustain high ambient temperature up to 50 °C with auto-derating.**

Integrated Backfeed Protection

Backfeed protection prevents any potential risk from electric shock on the UPS mains and bypass input AC terminals in the event of a failure of the rectifier and bypass static switch SCR. The control circuit includes output dry contacts that activates an internal isolating device (optional) upon backfeed detection.

Scalable up to 1.5 MW

6 units of intelligent paralleling helps to achieve maximum capacity up to 1.5 MW. Comes with Integrated Parallel and LBS communication ports, and allow single touch to initiate inverter ON/OFF for all parallel connected UPS system.

Symmetrical Power Factor Compatibility

Liebert EXM2 is fully adapted to meet diverse system requirements in terms of power capacity and redundancy allowing different system designs.

- Output Power Factor up to 1
- No power derating from 0.5 lagging to 0.5 leading
- Optimum space/power ratio

Intelligent Paralleling



15% 

Six units at 15% load each = 96% efficiency



30% 

Liebert® EXM2 Intelligent Paralleling: three units at 30% load each = 96.8% efficiency



User Interface and Advanced Diagnostic

Liebert® EXM2 makes your mission critical space a peaceful place through its **advanced diagnostic capability**, measuring and logging, enhanced event analysis as well as an intelligent colored multi-language touch screen display.

Liebert EXM2 advanced DSP control platform together with the patented Vector Control technology enables increased performance of three-level power converters and real time control of output power quality, **guaranteeing continuous operation and premium protection for your business.**

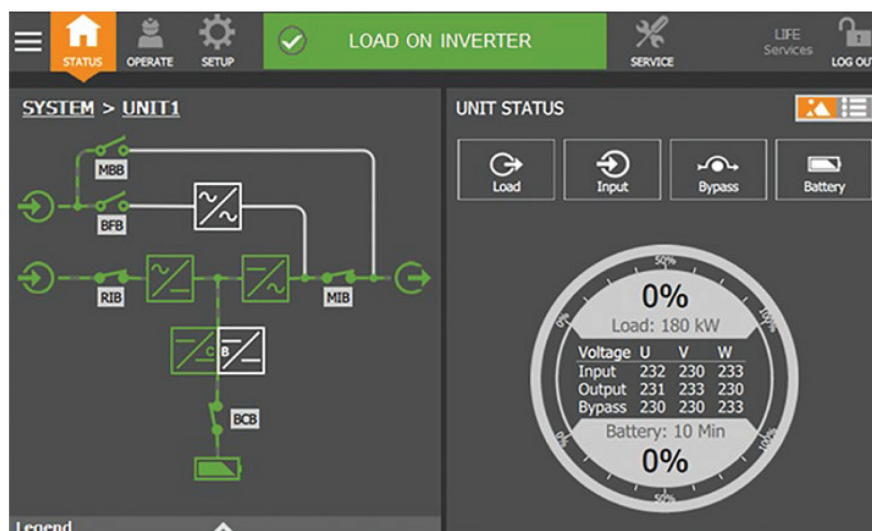

Bypass Input

Voltage and frequency measurements.

Mains Input

Current, voltage and frequency values of the three input phases.

Warning/fault

Alerts of anomalies on bypass, rectifier, inverter, booster/charger, battery and load.

Events log

Date and time of important UPS events, alarms and other warnings.

Measurements

Voltage, current and frequency values of each internal functional block.

Battery

Status/values including temperature, cell voltage, capacity run time and testing.

Vertiv™ LIFE™ Services

Status of Vertiv LIFE Services connections and calls.

Tools

LCD settings and language selection.

Output

Voltage, current, frequency, and battery measurements.

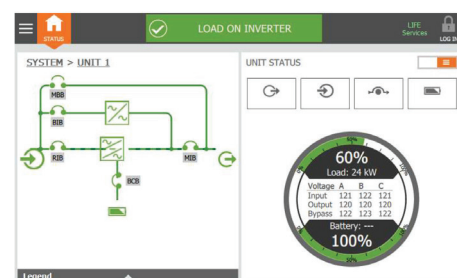
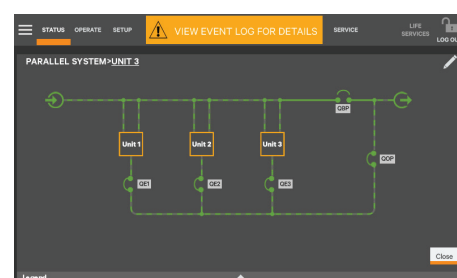

Lithium-ion Battery Compatibility

The Liebert® EXM2 is powered with **most powerful & intelligent battery charger that enables to integrate seamlessly with any Lithium-ion chemistry batteries.**



Vertiv® HPL lithium-ion cabinet battery with Liebert® EXM2 UPS

Considering the benefits lithium-ion batteries provides over traditional battery deployments. Not only do users enjoy the longer life, more cycles and fewer replacements, they also benefit from the compact, smaller size and lower weight. Plus, the higher operating temperature and lower maintenance add to the savings.

All these advantages directly impact IT facilities to drive an impressive total cost of ownership experience.

Vertiv leverages its DNA in critical systems to deliver a lithium-ion battery system that is integrated seamlessly into the power chain.

Our capabilities and processes come together to ensure the UPS, batteries, monitoring, management, service and support offerings are orchestrated for delivering on our customer expectations.

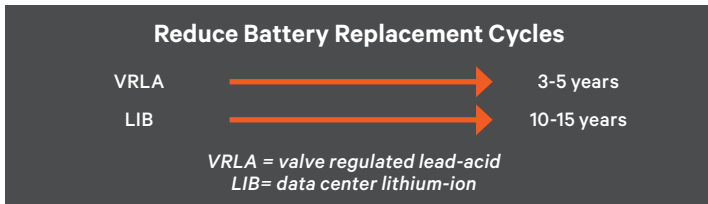

**Fewer Facility Disruptions
Lower Total Cost of Ownership**

Benefits of Lithium-ion Batteries

Longer life

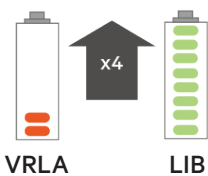

Weighs less

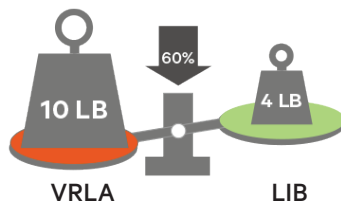

More cycles

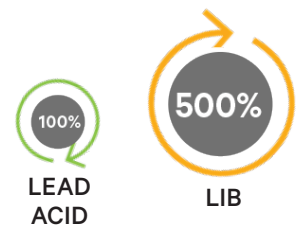

Saves space

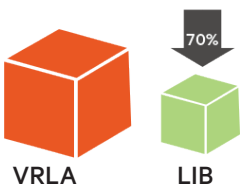

Saves cooling cost

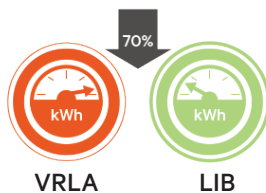

Battery Management System



Flexible Monitoring & Management Options

Hardware Connectivity

Liebert® EXM2 allows for the monitoring and control of networked UPS through different protocol options:

The integration of UPS with Building Monitoring and Automation Systems via MODBUS RTU, MODBUS/TCP Protocols and environment sensors.

The integration with synoptic panels via a dry contact board.

User configurable Input and Output contacts

- Monitoring external breakers
- Monitoring "on generator" signal
- Permissive signal for SKRU
- Trip external breakers

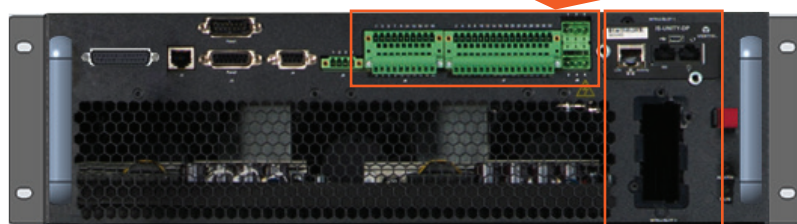

IS-UNITY-DP CARD

- Supports two simultaneous third party protocols (SNMP, Modbus TCP or RTU (485), BACNet IP or MSTP (485))
- WEB browser
- Email notifications
- SMS text messages
- SN series sensor support
- Vertiv™ LIFE™ services



IS-UNITY-LIFE CARD

- SNMP
- Email & SMS notifications (through LIFE Server)
- Vertiv™ LIFE™ services



IS-RELAY CARD

- Dry contact alarm notification



Designed for Easy Service and Maintenance

Designed for ease of service

Liebert® EXM2 is designed to allow access to cable terminal blocks, switches and all the replaceable components including power & bypass power modules and communications from the front side for both installation and maintenance purposes.

Modular Design and Construction

Common building blocks sub-assembly for an easy on-site replacement and reduced MTTR.



VERTIV™ LIFE™ Services Remote Diagnostic and Preventive Monitoring

Vertiv's service program is designed to ensure that your critical power protection system is maintained in an optimum state of readiness at all times.

The Vertiv™ LIFE™ Services remote diagnostic and preventive monitoring service provides early warning of UPS conditions and out of tolerances. This allows effective proactive maintenance, fast incident response and remote troubleshooting, giving customers complete security and peace of mind. With Vertiv LIFE Services you will benefit from:

Uptime Assurance

Constant monitoring of UPS parameters, thus maximizing the system's availability.

First Time Fix Rate

Pro-active monitoring and data measuring ensure that when our customer engineers are dispatched on-site, they arrive prepared for first time resolution.

Proactive Analysis

From Vertiv LIFE Service centers, our experts proactively analyze the data and trends of your equipment, to recommend actions to ensure their best performance.

Minimized Total Cost of Ownership of Your Equipment

The continuous monitoring of all relevant parameters in turn maximizes unit performance, reduces on-site maintenance and extends the life of your equipment.

Fast Incident Response

Vertiv LIFE Services allow for immediate definition of the best course of action, as a result of the regular communication between your Liebert® EXM2 system and our Vertiv LIFE Service centers.

Reporting

You will receive a comprehensive report detailing the working order of your equipment and its operational performance.

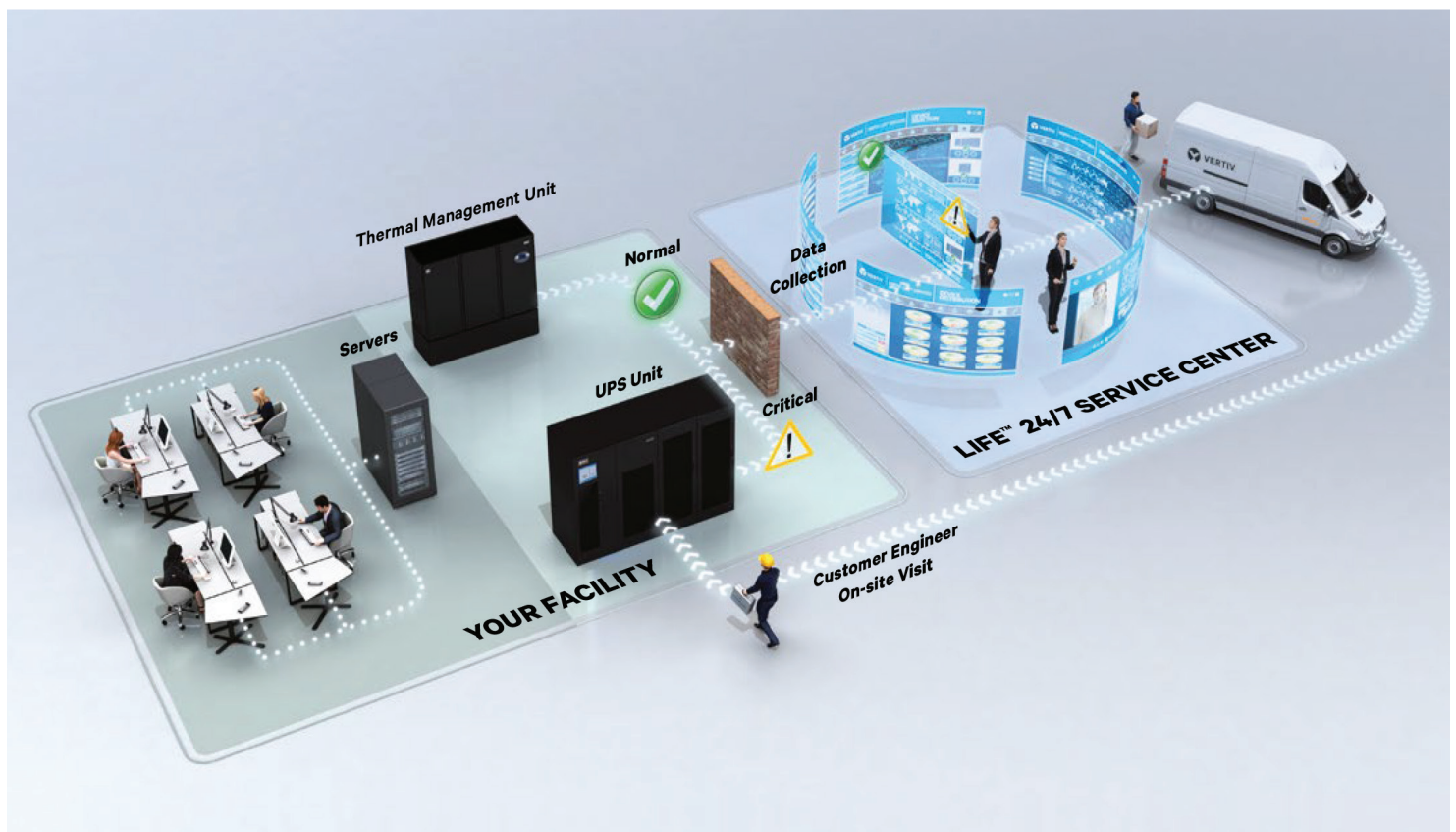

Technical Specifications

Nominal Ratings (kVA/kW)	100 kVA	120 kVA	160 kVA	200 kVA	250 kVA
Input					
Nominal input voltage (V)	380 / 400 / 415 (three-phase and sharing neutral with the bypass input)				
Input voltage range without battery discharge (V)*	228 to 478				
Nominal input frequency (Hz)	50 / 60				
Input frequency range (Hz)	40 to 70				
Bypass voltage tolerance (%)	Upper limit: +10, +15, or +20, default: +15 Lower limit: -10, -20, -30, -40, default: -20				
Bypass frequency tolerance (%)	±10				
Input power factor (kW/kVA)	0.99				
Input THDi*	<3% (full load), 4% (half load)				
Battery					
Battery bus voltage (VDC)	360 to 528, 2 Wire				
Battery charger max. (A)	30	45	45	60	75
Output					
Nominal output voltage (V)	380 / 400 / 415 (three-phase and sharing neutral with the bypass input)				
Nominal output frequency (Hz)	50 / 60				
Nominal active power (kW)	100	120	160	200	250
THDv with 100% linear load (%)	1				
Inverter overload capacity	<105 % for Continuous; <110% for 60min; <125 % 10 min; <150 % for 1 min; >150 % for 200ms				
Efficiency					
Double conversion mode	Up to 97%				
Dynamic online mode	Up to 98.8%				
Eco mode	Up to 99.2%				
Dimensions and weight¹					
Dimensions (W x D x H), mm	600 x 850 x 1600			600 x 850 x 2000	
Shipping dimensions (W x D x H), mm	800 x 1000 x 1800			800 x 1000 x 2180	
Weight, kg	315	350	350	412	447
Shipping weight, kg	345	380	380	443	478
General					
Noise at 1 m dBA	60			62	
Altitude	1500 m no derating, 1500 to 3000 m derate power by 1 % per each 100 m increase				
Protection level	IP20 IP21, IP31 optional				
General and safety requirements for UPS	IEC 62040-1				
EMC requirements for UPS	IEC 62040-2				
UPS classification according to IEC EN 62040-3	VFI-SS-111				
Central Power Supply Systems (CPSS) applications*	EN 50171				
Rail applications*	EN 50121-1; EN 50121-5				

* Conditions apply

1. Without side cabinet and top fan subassembly



Vertiv.com |

© 2021 Vertiv Group Corp. All rights reserved. Vertiv™ and the Vertiv logo are trademarks or registered trademarks of Vertiv Group Corp. While every precaution has been taken to ensure accuracy and completeness herein, Vertiv Group Corp. assumes no responsibility, and disclaims all liability, for damages resulting from use of this information or for any errors or omissions. Specifications are subject to change without notice.

MKA4LOUKEXM2-R1-03/2021

UPS-EXM2-BR-V1-0321-EN